

Technical data sheet

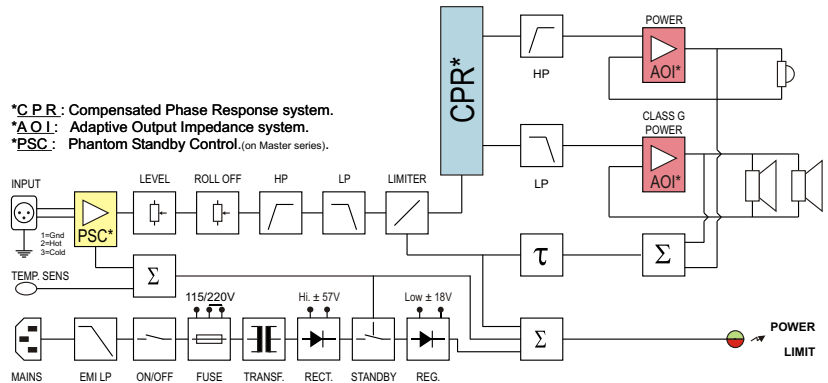

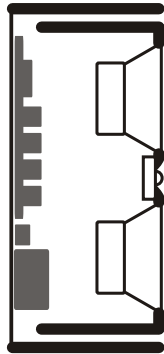

- Puissance RMS **120+40 W**
- Power RMS
- Puissance programme **160 W**
- Program power
- Impédance d'entrée **Sym, 10k Ohms**
- Input Impedance
- Sensibilité pour 100 dB @ 1m **0.775 V**
- Sensitivity for 100 dB @ 1m
- Rapport signal sur Bruit **-96 dBA**
- Signal to Noise Ratio
- Saturation d'entrée **24 Vpp**
- Input Overload
- Niveau max. continu, 1m **108 dB (single)**
- Continuous Max SPL, 1m
- Niveau max. programme, 1m **119 dB (pair)**
- Program Max SPL, 1m
- Réponse à -6 dB **53 - 23000 Hz**
- Response at -6dB
- Tolérances **±2 dB (60Hz - 20kHz)**
- Tolerances
- Distorsions THD **< 1.2% (120Hz-12kHz)**
- Distortion THD
- Phase tolérances **±45° (270Hz - 20kHz)**
- Phase tolerances
- Dispersion (B.R. 4 - 16 kHz) à -6 dB **90° x 60° (H x V)**
- Dispersion (P.N. 4 - 16 kHz) at -6 dB
- Système **2 Way(s)**
- System
- Fréquence de coupure **1.8 kHz**
- Crossover frequency
- Dim. basses Ext. / Membrane **2 x Ø 147 / Ø 104 mm**
- Woofers dim. Ext. / Diaphragm
- Dim. aigues Ext. / Membrane **Ø 100 mm / Ø 25 mm**
- Tweeter's dim. Ext. / Diaphragm
- Connecteurs **1 x XLR F / 3P**
- Connectors
- Signal entrée **1=GND, 2=(+), 3=(-)**
- Signal input
- Matériaux du boîtier **MDF**
- Box Material
- Dimensions boîtier L x H x P mm **166x 446 x 200**
- Dimensions cabinet W x H x D mm
- Poids brut / net **11.2 / 10.2 Kg**
- Gross / Net Weight
- Tension de secteur **115/230V (50-60Hz)**
- Voltage
- Consommation **2.5 - 8 - 150 VA**
- Consumption Standby-Quiescent-Max
- Humidité Moy / Max **< 75% / < 90%**
- Mean / Max Humidity
- Température externe **5 - 40 °C**
- External Temperature

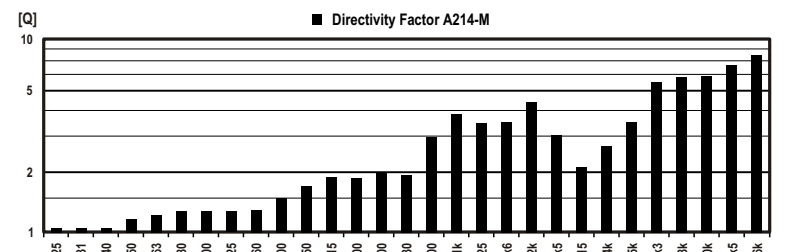
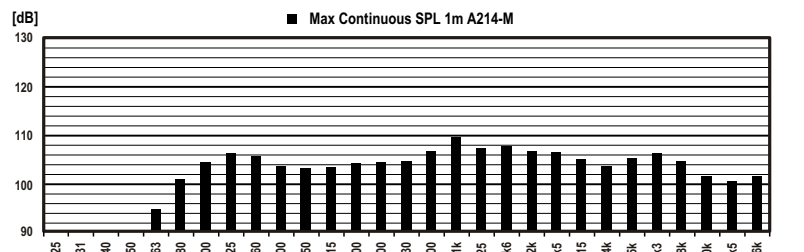
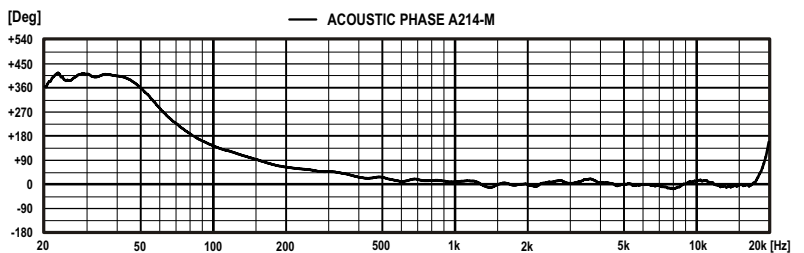
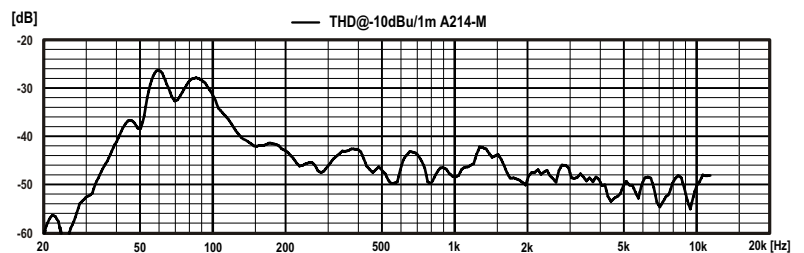
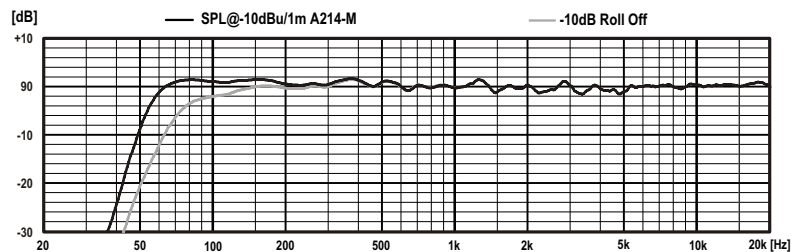

All dimensions are in mm

Mounting

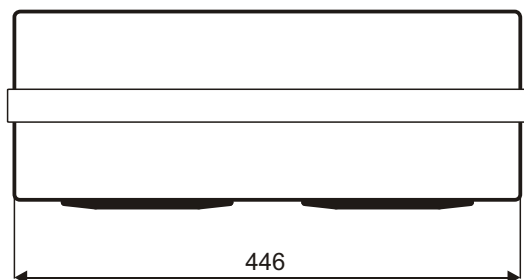

Bottom/Top view

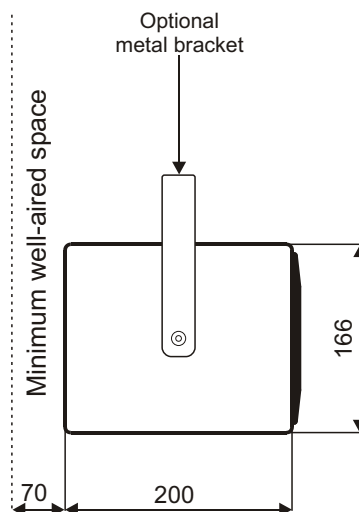

Side view

Acoustical axis

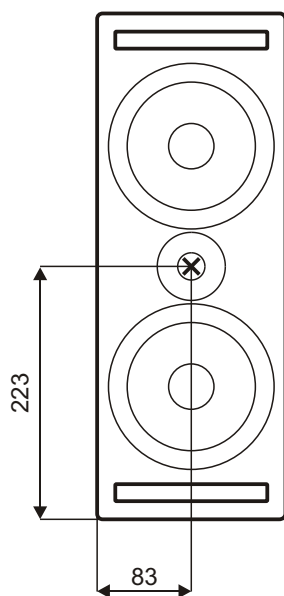

Front view

Measurement environment: Large anechoical room
 Temperature $23 \pm 2^\circ\text{C}$
 Humidity $50 \pm 20\%$